

REVISIONS				
ZONE	REV	DESCRIPTION	DATE	APPROVED

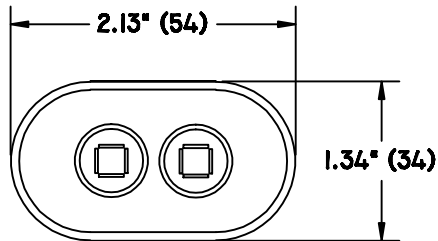

**SPECIFICATION**

**CAPACITANCE: 0.80 UF +/-3%**  
**RATED VOLTAGE: 2,500 VAC @ 50/60 HZ**  
**OPERATING TEMPERATURE: -10°C ~ +85°C**  
**CASE: ALUMINUM**  
**TERMINALS: THREE-BLADE AMP .250 QUICK-CONNECT**  
**DIELECTRIC: COMPOSITE**  
**DISSIPATION FACTOR: <0.30%, 50 HZ.)**  
**BLEEDER RESISTOR: 10 M OHMS**

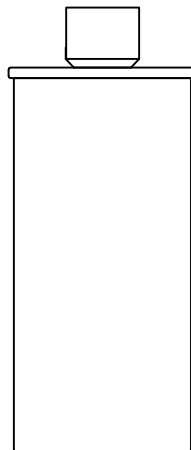
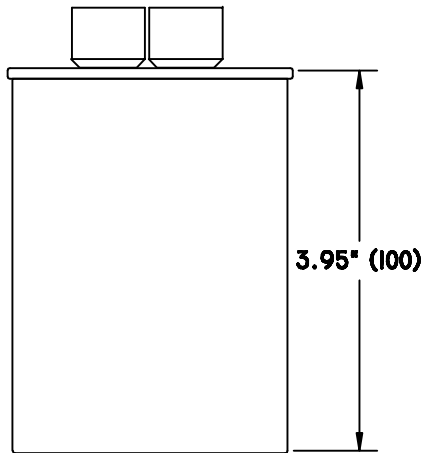

**STAMPING**

**MANUFACTURER / PART NUMBER**  
**CAPACITANCE / TOLERANCE / VOLTAGE**  
**TEMP. RATING / NO PCB'S**



<b>Motor Capacitors, Inc</b> Division of Capacitor Industries 335 Beinoris Drive Wood Dale, IL 60191	<small>HCI PART NUMBER</small> <b>CH85-2500-804</b>		
	<small>CUSTOMER PART NUMBER</small> -----		
<small>DRAWING BY:</small> <b>JDGA</b>	<small>DATE DWG</small> <b>08/06/15</b>	<small>DWG NO.</small>	<small>REV</small>
<small>APPROVED BY:</small> <b>LD</b>	<small>SCALE</small>	<small>SHEET</small>	