

Part Number	CD60M-2EJ189227R		Revision
Customer P/N			Revision
Capacitance	189	to	227 uF.
Voltage	250		VAC
Dielectric	Aluminum Electrolytic Motor Start		
Terminal Type	Dual .250" X .03" Quick Connect Terminals		
Operating Temperature	-40	to	65 °C.
Dissipation Factor	0.1		max. @ 60 Hz.

MOTOR Capacitors, Inc.

Motor Capacitors, Inc.
 335 Beinoris Drive
 Wood Dale, Illinois 60191
 773-774-6666 (Phone) | 773-774-6690 (Fax)
www.capacitorindustries.com
info@capacitorindustries.com

	Dimension	Tolerance
Diameter (D)	2.06	0.03
Terminal Spacing (C)	0.43	ref.
Height (L)	4.37	0.06
Quick-Connect Terminal	double	F

Dimensions in inches

Stamping

Motor Capacitors
CD60M-2EJ189227R
189-227 uF. 250 VAC

NOTE: 15K Ohm Discharge Resistor Attached

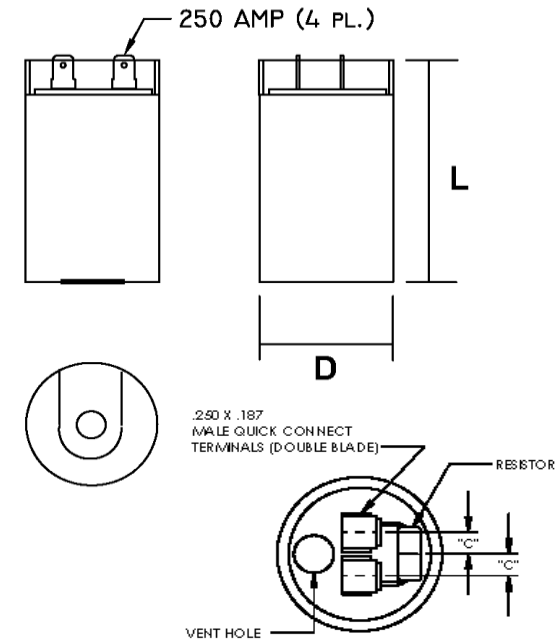

Approval: J.D. Aldana
 Date: April 14, 2000