

Part Number	CBB66A-440R166-M8		Revision
Customer P/N			Revision
Capacitance	16	uF.	Tolerance 10.0%
Voltage	440	VAC	
Dielectric	Metallized Polypropylene		
Terminal Type	.250" Quad-Spade Quick Connect Terminals		
Operating Temperature	-25 oC.-	100 °C.	
Dissipation Factor	0.0001	maximum @ 60 Hz.	

MOTOR Capacitors, Inc.

Motor Capacitors, Inc.

335 Beinoris Drive

Wood Dale, Illinois 60191

773-774-6666 (Phone) | 773-774-6690 (Fax)

www.capacitorindustries.com

info@capacitorindustries.com

	Dimension	Tolerance
Diameter (D) Case/Cover	1.96	0.06
Case Height (H)	3.35	0.06
Terminal Height (K)	0.56	ref.
Terminal-Terminal (M)	0.83	ref.
Insulating Cup (dia.)	0.74	
M-8 Stud	Yes	

Dimensions in inches

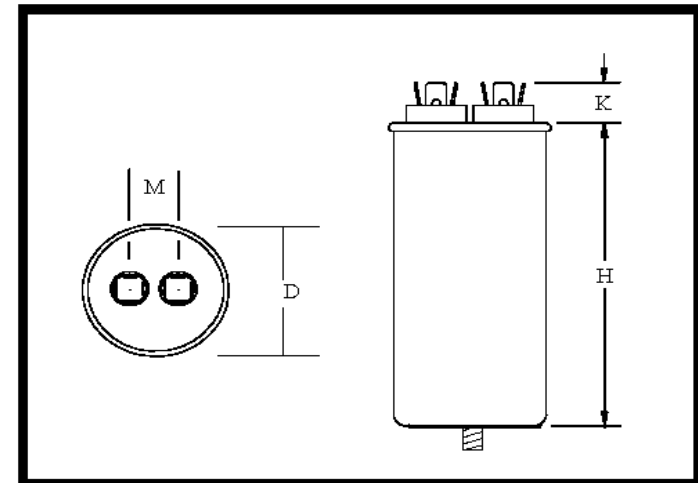
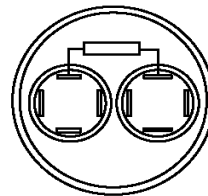

Stamping	
	AHJK - Motor Cap
	CBB66A-440R166-M8
	16 uF 10% 440 VAC
	100 C Max. 50/60Hz.
	Protected 10,000 AFC
	RU
	Non PCB Date Code RoHs



with discharge resistor and M8 Stud
Metal Halide Lighting Capacitor

Engineer J.D. Aldana
Date June 24, 2010